

- Remove the oil filter with a filter wrench and let the remaining oil drain out. Make sure the prior seal is not stuck to the engine.

► Discard the oil and oil filter at an approved recycling center.

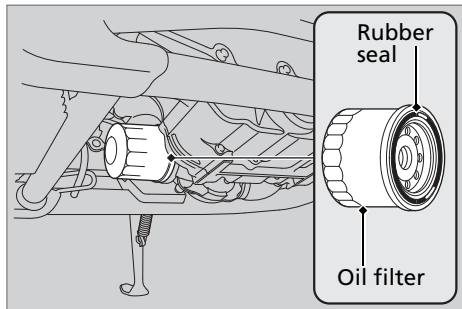

- Apply a thin coat of engine oil to the rubber seal of a new oil filter.
- Install the new oil filter and tighten.

Torque: 19 lbf·ft (26 N·m, 2.7 kgf·m).

- Install a new sealing washer onto the drain bolt. Tighten the drain bolt.

Torque: 21 lbf·ft (29 N·m, 3.0 kgf·m).

- Fill the crankcase with the recommended oil (► P. 42, 118) and install the oil fill cap/dipstick.

Required oil
When changing oil & engine oil filter:

2.7 US qt (2.6 liters)

When changing oil only:

2.6 US qt (2.5 liters)

- Check the oil level. ► P. 53
- Check that there are no oil leaks.