

Blown Fuse

Before handling fuses, see "Inspecting and Replacing Fuses." ► P. 50

Fuse Box Fuses

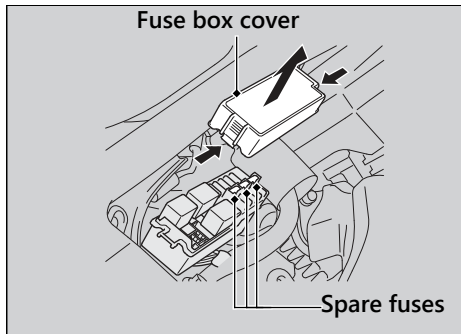

1. Remove the right side cover. ► P. 63
2. Remove the fuse box cover.
3. Pull out the fuses one by one to check for a blown fuse. Always replace a blown fuse with a spare fuse of the same rating.
4. Reinstall the fuse box cover.
5. Reinstall the right side cover.