

Brakes

Fluid Level Inspection

Refer to *Safety Precautions* on page 95 .

RIGHT HANDLEBAR

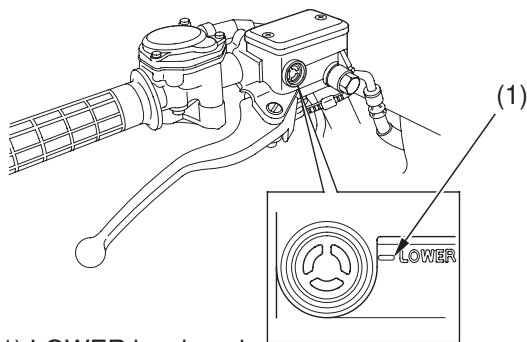

(1) LOWER level mark

If your inspection indicates a low fluid level, have your Honda dealer add the recommended fluid.

Do not add or replace brake fluid, except in an emergency. If you do add fluid, have your Honda dealer check the system as soon as possible.

NOTICE

Brake fluid can damage plastic and painted surfaces. Handle with care.

With the ATV in an upright position, check the fluid level. It should be above the LOWER level mark (1). If the level is at or below the LOWER level mark, check the brake pads for wear (page 144).

Worn brake pads should be replaced. If the pads are not worn, have your brake system inspected for leaks.