

Tank Cover Assembly Removal

Refer to *Safety Precautions* on page 109.

The tank cover assembly must be removed for the engine oil filter and spark plug maintenance.

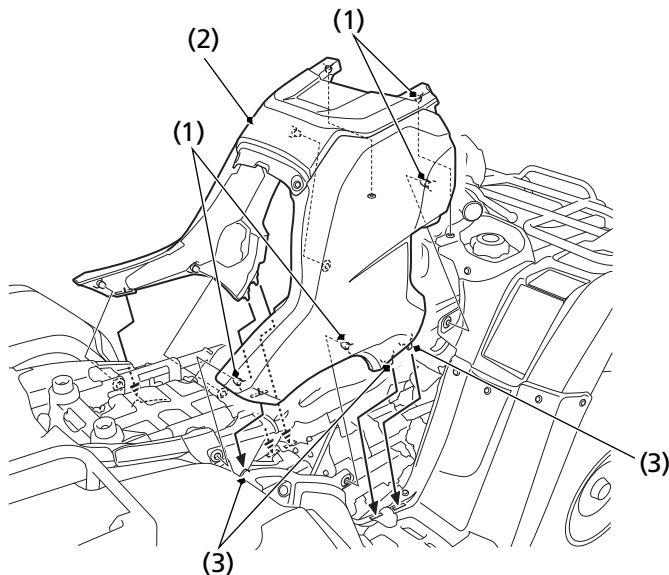

(1) right studs

(3) right tabs

(2) tank cover assembly

Removal

1. Remove the seat (page 120).
2. Carefully remove the right studs (1) and left studs from the grommets.
3. Remove the tank cover assembly (2) by releasing the right tabs (3) and left tabs from the slits.

Installation

Install the tank cover assembly in the reverse order of removal.