

Owner's Manual Storage

Your ATV provides storage for the owner's manual so you'll have it with you for easy reference. Store your owner's manual (1) in the plastic document bag (2) underside of the rear fender cover (3).

The owner's manual and air pressure gauge (4) should be stored in the plastic document bag and fastened with the rubber band (5).

To remove the rear fender cover, see [page 121](#).

Be careful not to flood this area when washing your ATV.

REAR FENDER COVER UNDERSIDE

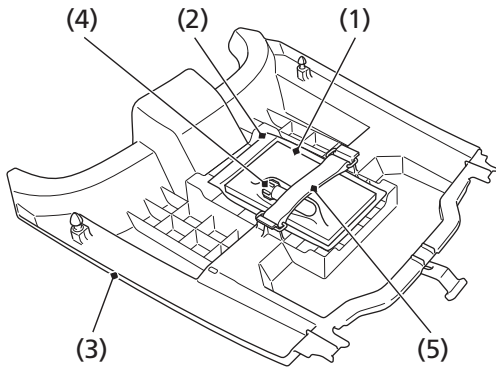

- | | |
|--------------------------|------------------------|
| (1) owner's manual | (4) air pressure gauge |
| (2) plastic document bag | (5) rubber band |
| (3) rear fender cover | |