

Seat Removal

Refer to *Safety Precautions* on page 139.

The seat must be removed for the air cleaner, spark plug, battery and fuse maintenance and to access the owner's manual and tool kit.

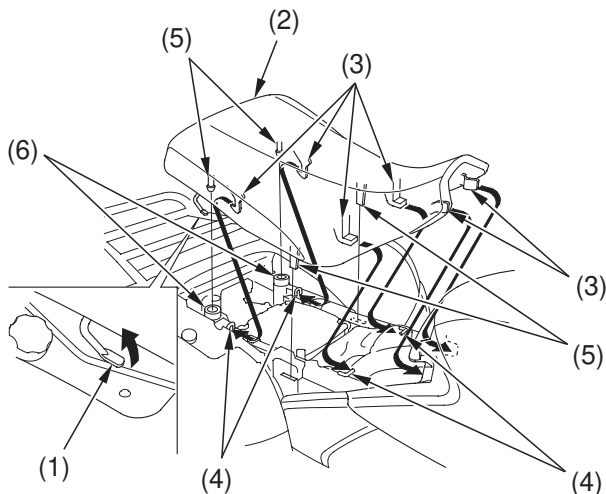

(1) seat lock lever

(2) seat

(3) prongs

(4) hooks

(5) studs

(6) grommets

Removal

1. Pull the seat lock lever (1) at the right side of the seat.
2. Slide the seat (2) back and lift it.

Installation

1. Insert the prongs (3) into the hooks (4) on the frame and press the studs (5) into the grommets (6).
2. Press down on the seat until locks.