

# Battery

The battery is located in a compartment under the rear fender cover.

## UNDER REAR FENDER COVER

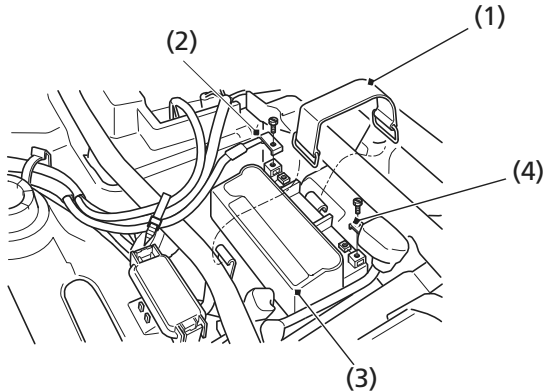

(1) rubber band

(3) battery

(2) negative (-) terminal lead

(4) positive (+) terminal lead

### Removal

1. Make sure the ignition switch is OFF (O).
2. Remove the seat ([page 114](#)).
3. Remove the rear fender cover ([page 138](#)).
4. Release the rings and remove the rubber band (1).
5. Disconnect the negative (-) terminal lead (2) from the battery (3) first, then disconnect the positive (+) terminal lead (4).

(cont'd)