

Tool Kit

The tool kit (1) and the gear change tool (2) are stored under the rear fender cover (page 123).

After using the tool kit or the gear change tool, be sure to use the rubber band (3) to fasten the tool kit and the gear change tool securely.

An optional, larger tool kit may be available. Check with your dealer's parts department.

UNDER REAR FENDER COVER

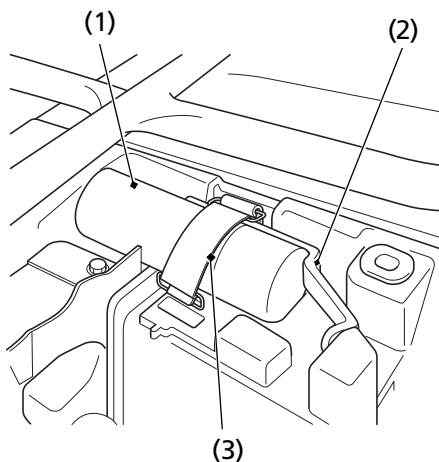

(1) tool kit

(2) gear change tool

(3) rubber band