

Battery

The battery is located in a compartment under the seat.

UNDER SEAT

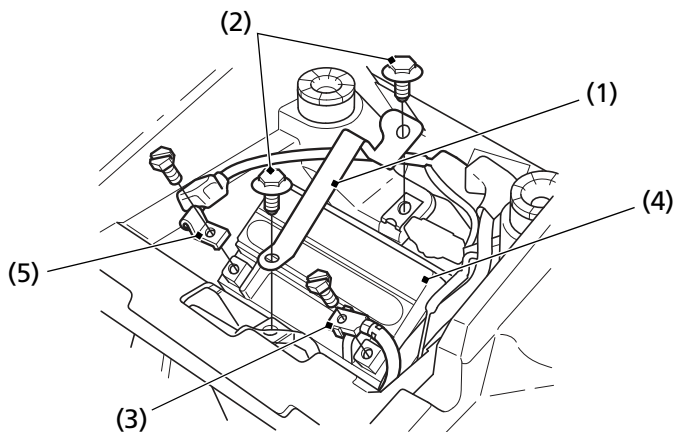

(1) battery holder

(2) mount bolts

(3) negative (-) terminal lead

(4) battery

(5) positive (+) terminal lead

Removal

1. Make sure the ignition switch is OFF (O).
2. Remove the seat (page 86).
3. Remove the battery holder (1) by removing the mount bolts (2).
4. Disconnect the negative (-) terminal lead (3) from the battery (4) first, then disconnect the positive (+) terminal lead (5).
5. Remove the battery.