

Fuel

Fuel Capacity

Fuel tank capacity, including reserve:

2.40 US gal (9.1 ℓ)

Reserve capacity:

0.63 US gal (2.4 ℓ)

The tank should be refilled as soon as possible after switching to reserve, and the fuel valve should be returned to the ON position after refueling to avoid running out of fuel with no reserve.

Refueling Procedure

Refer to *Safety Precautions* on page 79.

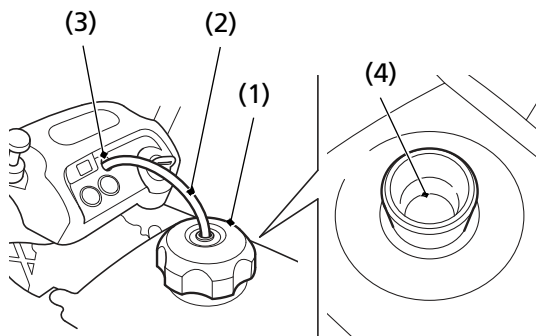

(1) fuel fill cap

(2) breather tube

(3) handlebar cover hole

(4) bottom of filler neck