

Controls & Features

Reverse Selector Knob

The reverse selector knob (1), located on the rear brake lever/parking brake lever (2), is used to shift into reverse. To operate, with your ATV stopped and the transmission in neutral (make sure the gear position indicator shows “N”), push in the knob, squeeze the rear brake lever/parking brake lever, then press the downshift switch (3) once. See *Riding in Reverse*, page 59.

LEFT HANDLEBAR

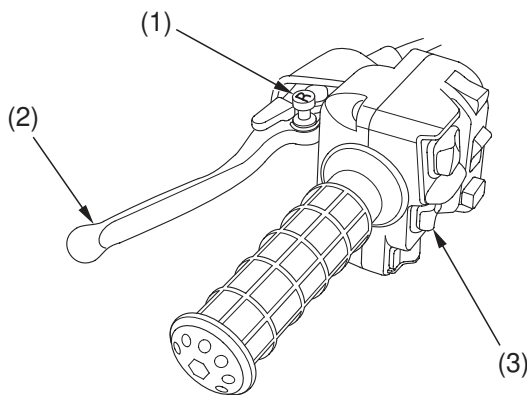

(1) reverse selector knob
(2) rear brake lever/
parking brake lever

(3) downshift switch