

# Engine Oil & Filters

## *Install a New Engine Oil Filter:*

*Place shop towels under the oil filter cover because oil will flow out.*

6. Remove the engine oil filter cover (ENG marked) and O-ring by removing the bolts. Let the remaining oil drain out. Discard the oil filter in an approved manner (page 221).
7. Apply engine oil to a new O-ring and install it to the engine oil filter cover. Install a new oil filter.  
Use only the Honda Genuine oil filter or a filter of equivalent quality specified for your model. Using the wrong Honda filter, inserting a filter in backwards, using a filter with no OUTSIDE markings, or a non-Honda filter which is not of equivalent quality may cause engine damage.
8. Install a new filter with the OUTSIDE mark facing outward, reinstall the spring and engine oil filter cover making sure the bolts are tightened to the specified torque:  
**9 lbf·ft (12 N·m, 1.2 kgf·m)**

## NOTICE

*Improper installation of the oil filter can cause serious engine damage.*

### UNDER LEFT REAR FENDER

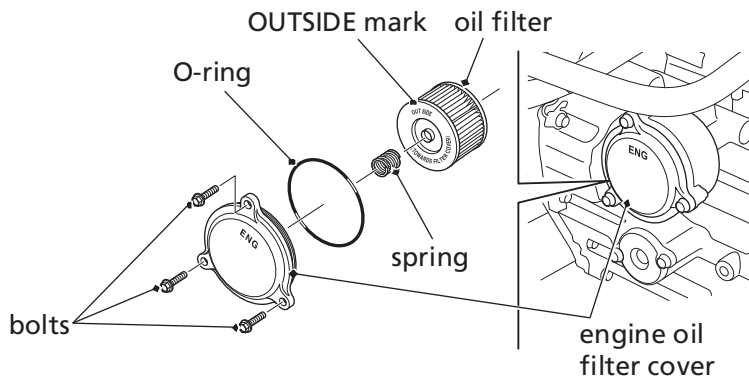

(cont'd)