

Driveshaft Boots

Refer to *Safety Precautions* on page 123.

Check the rubber boots for tears or traces of splattered grease.
If necessary, have your dealer replace them.

FRONT

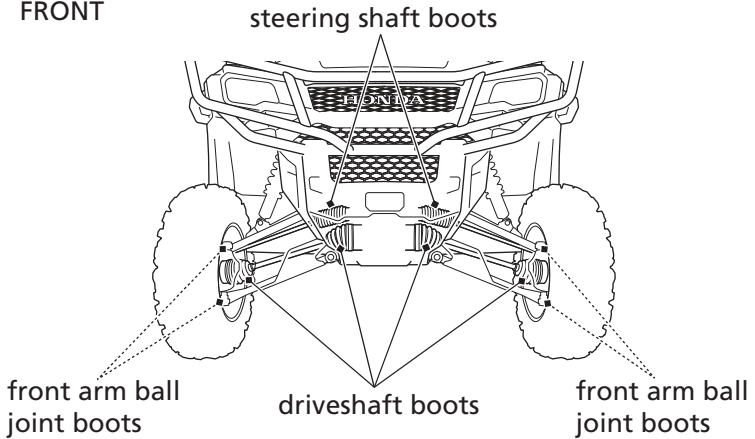

REAR

