

Cargo Bed Controls

See page 81 for *Loading Cargo* when driving with cargo in the bed.

Tailgate Levers

Before lowering the tailgate, select a firm level surface and shift the shift select lever into the park (P) position.

To lower the tailgate, pull each tailgate lever out and unhook the hook as shown below. Reverse the process to secure the tailgate in the upright position.

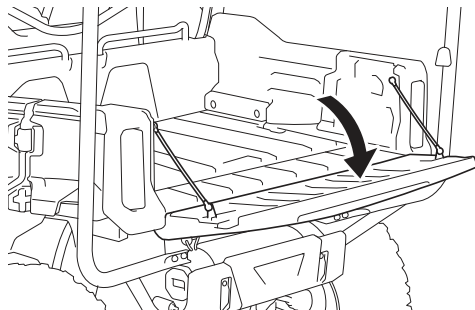
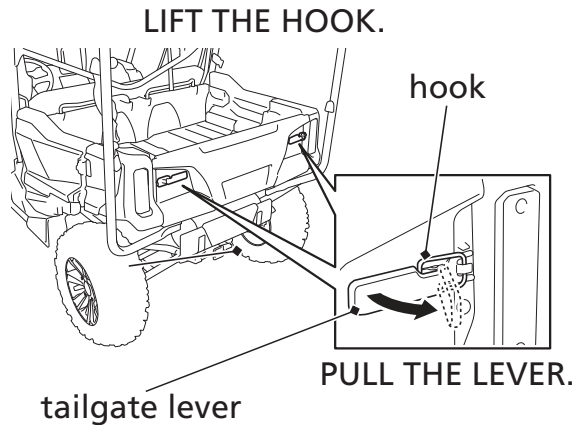

TILT GENTLY.

Do not drive the Honda SXS with the tailgate lowered.