

Center Cover

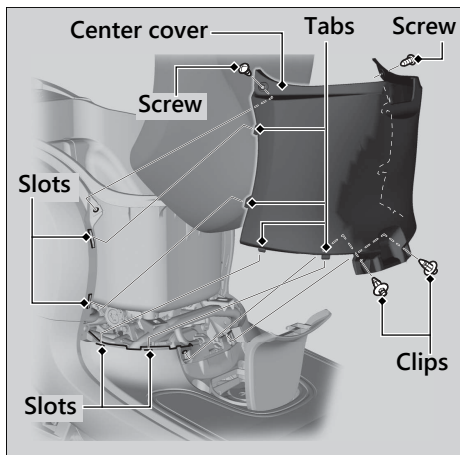

Removal

1. Open the seat and fuel lid. ► P. 36, ► P. 38
2. Remove the screws and clips. ► P. 65
3. Pull the bottom of the center cover up and forward, remove the tabs from their slots.
4. Remove the center cover.

Installation

Install the parts in the reverse order of removal.