

Maintenance Lid

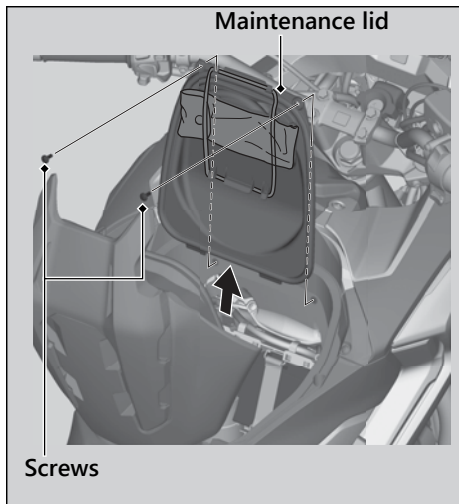

Removal

1. Open the luggage box. ► P. 69
2. Remove the screws.
3. Remove the maintenance lid.

Installation

1. Install the maintenance lid.
2. Install and tighten the screws.

Torque: 2.2 lbf·ft (3 N·m, 0.3 kgf·m)

3. Close the luggage box.