

Clutch System

Your motorcycle has a hydraulically-actuated clutch. There are no adjustments to perform, but the clutch system must be inspected periodically for fluid level and leakage.

If the motorcycle creeps or stalls when shifted into gear, or if the clutch slips, causing acceleration to lag behind engine speed, there is probably air in the clutch system. See your dealer to have the air bled out of the system.

Clutch Lever Adjustment

Refer to *Safety Precautions* on page 154.

The distance between the tip of the clutch lever and the grip may be adjusted.

LEFT HANDLEBAR

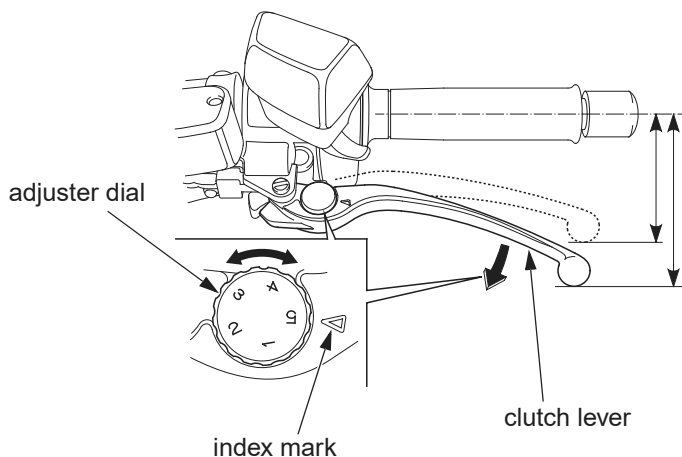

1. Turn the adjuster dial while pushing the clutch lever forward.
2. Align the index mark on the clutch lever with the numbers on the adjuster dial.
3. Start the engine, pull the clutch lever in, and shift into gear. Make sure the engine does not stall and the motorcycle does not creep. Gradually release the clutch lever and open the throttle. Your motorcycle should move smoothly and accelerate gradually.