

Clutch System

Fluid Level Inspection

Refer to *Safety Precautions* on [page 122](#).

LEFT HANDLEBAR

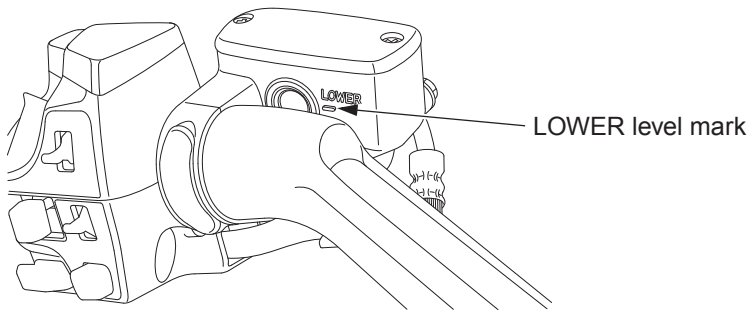

Check that the fluid level is above the LOWER level mark. If the fluid level is below the LOWER level mark, it indicates fluid leakage. See your dealer for repair.

Other Inspections

- Make sure there are no fluid leaks.
- Check for deterioration or cracks in the hose and fittings.
- Check that the clutch lever assembly is positioned properly and the securing bolts are tight.