

Suspension

12. Loosen the fork bridge lower pinch bolts (27), then pull the fork legs down and out.

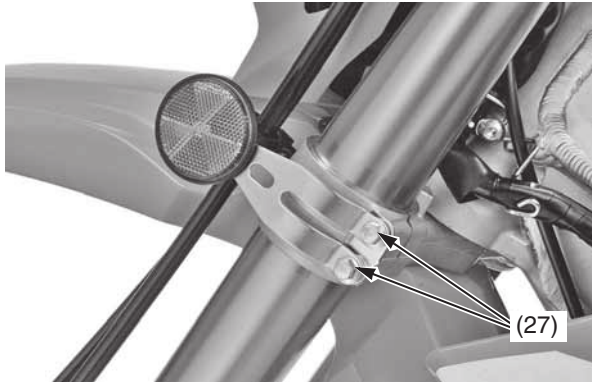

(27) fork bridge lower pinch bolts

13. Clean the fork assembly, especially the sliding surface (28) of the slider and fork dust seal (29).
 14. Measure the length (30) between the axle holder and outer tube and record it before disassembling the fork.

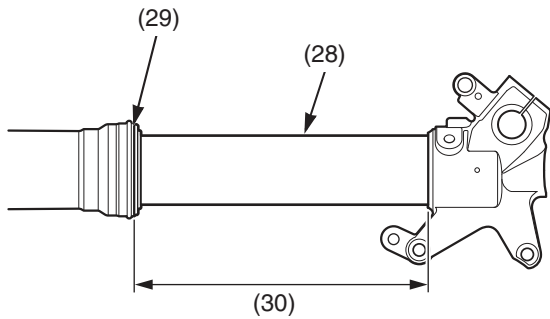

(28) sliding surface
 (29) fork dust seal
 (30) length

Recommended Fork Oil

suggested oil	Pro Honda HP Fork Oil, SS-19
---------------	------------------------------

Fork Outer Tube Disassembly

Refer to *Front Suspension Removal* on page 106.

1. Clean the fork assembly, especially the sliding surface of the slider and dust seal.
 2. Hold the outer tube (1), then remove the fork damper assembly (2) from the outer tube using the lock nut wrench (3). Gently slide the outer tube down onto the lower end (axle holder) (4).
- Lock nut wrench 07WMA-KZ30100

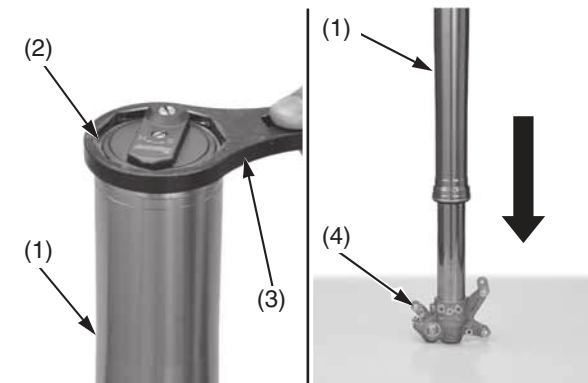

(1) outer tube
 (2) fork damper assembly
 (3) lock nut wrench
 (4) axle holder

NOTICE

The outer tube (1) can drop on the axle holder (4) and damage the fork dust seal (5). To avoid damage, hold both the outer tube and slider when removing the fork damper.

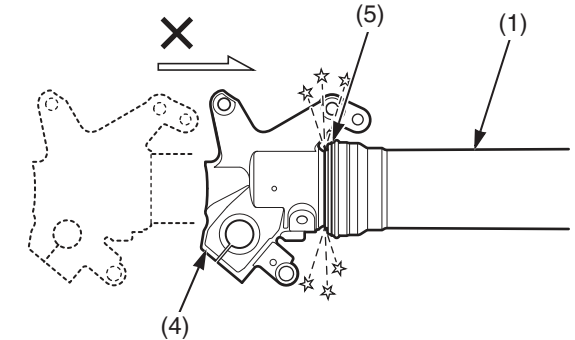

(1) outer tube
 (4) axle holder
 (5) fork dust seal

3. Drain the fork oil from the outer tube (1) and oil holes (6) of the fork damper assembly (2). Remove the O-ring (7) from the fork damper assembly.

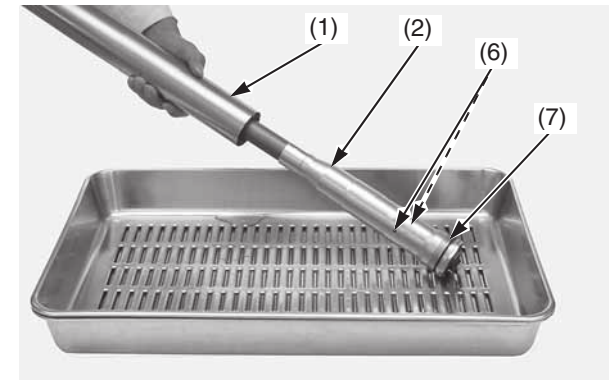

(1) outer tube
 (2) fork damper assembly
 (6) oil holes
 (7) O-ring