

Carburetor Adjustments & Tuning Tips

To assemble, reverse the disassembly procedures.
To install the carburetor, reverse the removal procedures.

Tighten the following parts to the specified torque.

float bowl screws:

1.5 lbf·ft (2.1 N·m, 0.2 kgf·m)

float bowl plug:

3.6 lbf·ft (4.9 N·m, 0.5 kgf·m)

accelerator pump cover screws:

1.5 lbf·ft (2.1 N·m, 0.2 kgf·m)

carburetor top screws:

1.5 lbf·ft (2.1 N·m, 0.2 kgf·m)

jet needle/holder assembly:

1.5 lbf·ft (2.1 N·m, 0.2 kgf·m)

link arm torx screw:

1.5 lbf·ft (2.1 N·m, 0.2 kgf·m)

throttle drum cover bolt:

2.5 lbf·ft (3.4 N·m, 0.3 kgf·m)

hot start cable nut:

1.5 lbf·ft (2.1 N·m, 0.2 kgf·m)

throttle cable lock nut:

3.0 lbf·ft (4.0 N·m, 0.4 kgf·m)

leak jet:

0.2 lbf·ft (0.3 N·m, 0.03 kgf·m)

main jet:

1.1 lbf·ft (1.5 N·m, 0.2 kgf·m)

slow jet:

1.1 lbf·ft (1.5 N·m, 0.2 kgf·m)

- Route the throttle cables (1), hot start cable (2) and throttle position sensor wire correctly.
- After installing the carburetor, adjust the throttle grip freeplay and hot start lever freeplay.
- After installing the carburetor, check the throttle position sensor connector (3) for correct routing.
- After installing the carburetor, check the air vent hoses (4) and overflow hose (5) for kinking or pinching and correct routing.
- Check that the U-ring and O-ring are in good condition. Replace them if necessary.

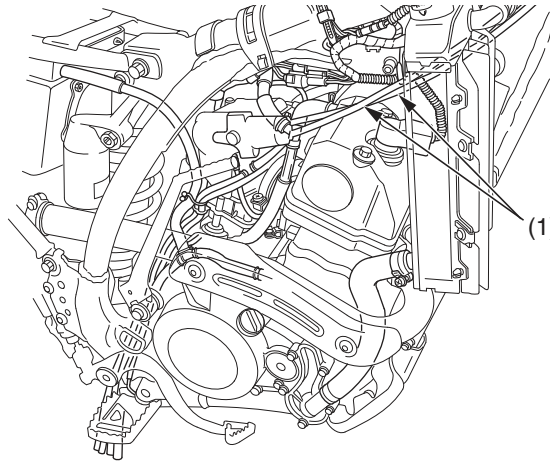

(1) throttle cables

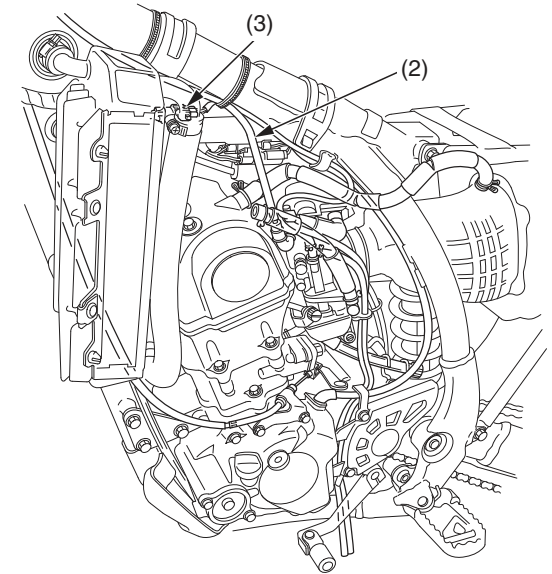

(2) hot start cable
(3) throttle position sensor connector

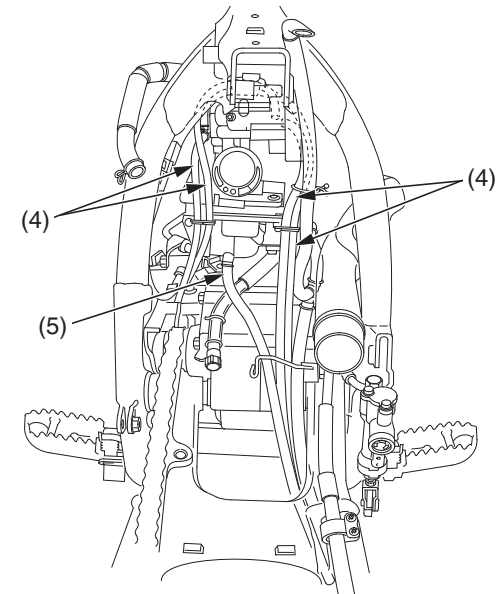

(4) air vent hoses
(5) overflow hose