

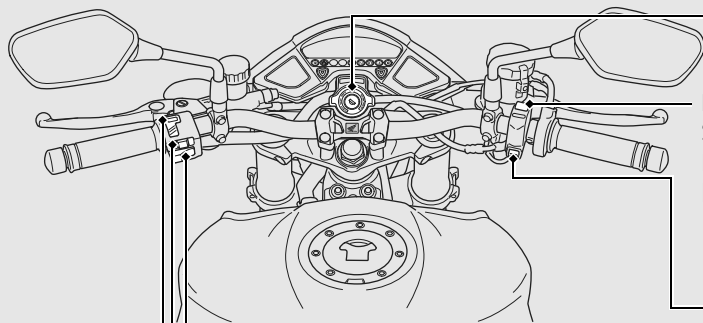

# Switches





 **Horn button**

 **Turn signal switch**

▶ Pressing the switch turns the turn signal off.

**Headlight dimmer switch**

-  D: High beam
-  D: Low beam

**Engine stop switch**

Should normally remain in the Run  position.

▶ In an emergency, switch to the Off  position to stop the engine.

 **Start button**