

Measure the O.D. of the piston at 3.5 mm (0,1378 in) from bottom of skirt and 90 degrees to the piston pin hole.

Service limit: 79.995 mm (3.1478 in)

If the O.D. is under the service limit, replace the piston with a new one.

Calculate the piston-to-cylinder clearance.

Service limit: 0.18 mm (0.007 in)

Measure the piston pin bore I.D.

Service limit: 16.03 mm (0.631 in)

Check the piston pin for wear or excessive discoloration. Measure the piston pin O.D.

Service limit: 15.98 mm (0.629 in)

Replace the piston pin if necessary.

Calculate the piston pin-to-piston clearance.

Service limit: 0.04 mm (0.002 in)

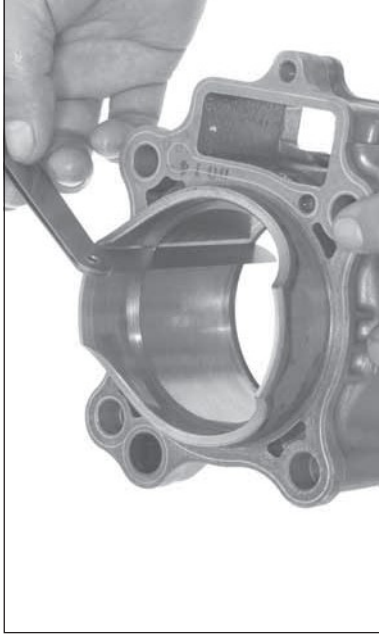

Insert each piston ring into the cylinder and measure the ring end gap. Push the ring into the cylinder with the top of the piston to be sure the ring is squarely in the cylinder.

Service limit:

Top: 0.390 mm (0,015 in)

Second: 0.64 mm (0.025 in)

Oil (side rail): 0.90 mm (0.035 in)



Connecting Rod

Measure the connecting rod small end I.D.

Service limit: 16.04 mm (0.631 in)

If the I.D. is not over the service limit, replace the piston pin.

If the I.D. is over the service limit, replace the crankshaft (page 4-54).