

Brakes

Rear Brake Fluid Level

RIGHT SIDE

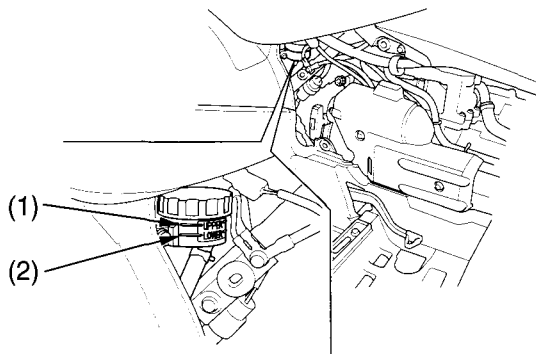

(1) UPPER level mark

(2) LOWER level mark

Remove the right side cover.

It should be between the UPPER (1) and LOWER (2) level mark. If the level is at or below the LOWER level mark, check the brake pads for wear (page 185).

Worn brake pads should be replaced. If the pads are not worn, have your brake system inspected for leaks.

Other Inspections

- Make sure there are no fluid leaks.
- Check for deterioration or cracks in the hoses and fittings. If the hoses are worn or cracked, have them replaced by your Honda dealer.