

Seat Removal

Refer to *Safety Precautions* on page 129.

The seat must be removed for the air cleaner, spark plug, and fuse maintenance.

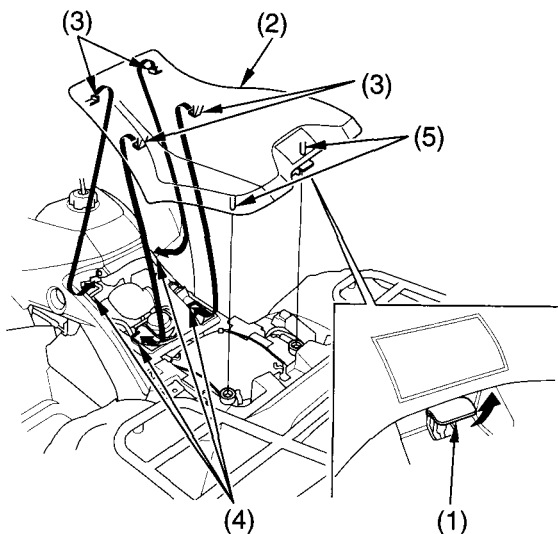

(1) seat latch

(2) seat

(3) front prongs

(4) hooks

(5) studs

Removal

1. Pull the seat latch (1) at the rear of the seat.
2. Slide the seat (2) back and lift it.

Installation

1. Insert the front prongs (3) into the hooks (4) and press the studs (5) into the grommets on the rear fender.
2. Press down on the seat until locks.