

Coolant

Radiator Core

Refer to *Safety Precautions* on page 97.

Check the air passages for clogging or damage. Remove insects, mud, or any obstruction with low water pressure. Have the radiator checked by your Honda dealer if the air flow is restricted over more than 20% of the radiator surface.

Clean the radiator core after riding the ATV in mud.

To clean the radiator core, oil cooler and radiator cover plate:

1. Unhook the tabs (1).
2. Remove the radiator cover plate (2).
3. Wash the radiator core (3), oil cooler (4) and radiator cover plate.

NOTICE

Do not apply pressured water directly to the radiator core and oil cooler. The pressured water can damage the radiator core.

FRONT

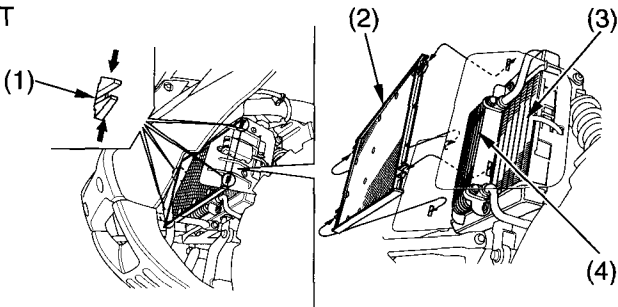

(1) tabs
(2) radiator cover plate

(3) radiator core
(4) oil cooler