

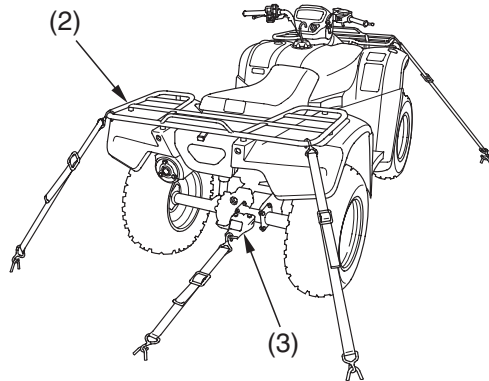

Transporting Your Honda

- Secure the vehicle with tie-down straps in the areas shown.
 - Suitable tie-down straps are available from your Honda dealer.
 - Ordinary rope is not recommended because it can stretch under load.
 - Using tie-down straps in any other areas can damage your ATV.
- Rock the vehicle back and forth to make sure the tie-down straps are tight and the vehicle is secure.

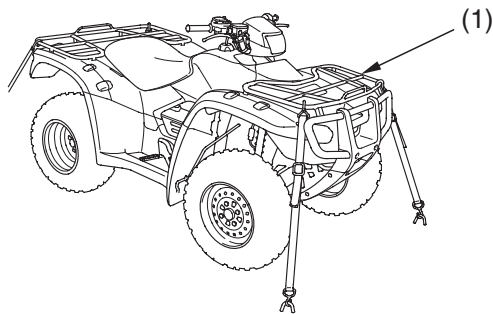

(1) front cargo rack
(2) rear cargo rack

(3) trailer hitch

Tips 175