

Trailer Hitch

The trailer hitch is located on the rear axle housing. As illustrated in Fig. 2-34 , to use the hitch, you'll need a proper size ball as specified by the trailer manufacturer.

To attach the ball and properly hook up a trailer, follow the trailer manufacturer's instructions. For load limits and operational guidelines, see pages 55 – 57.

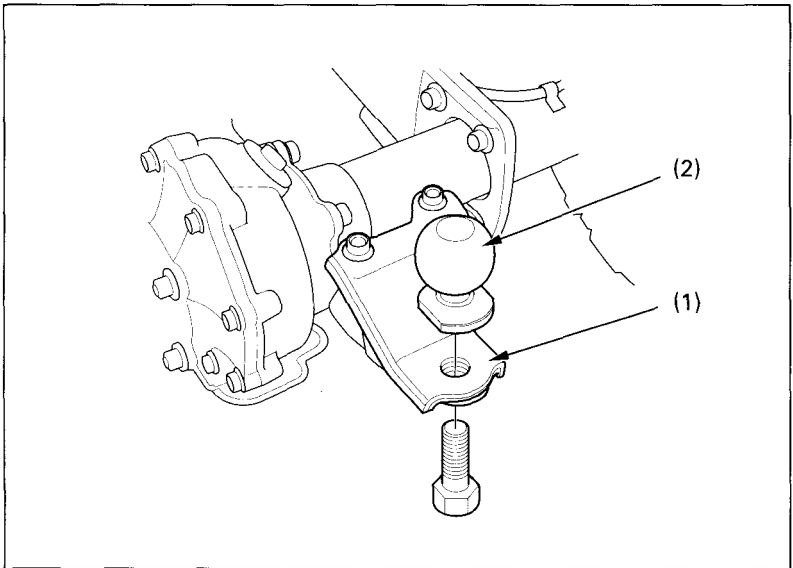

Fig. 2-34 (1) Trailer hitch

(2) Trailer hitch ball