

SERIAL NUMBERS AND COLOR LABEL

The frame, engine and key numbers (Fig. 5-1) will be needed when you order replacement parts. The color is also helpful. Record the numbers and color here for your reference.

The frame serial number (2) is stamped on the front of the frame. The engine serial number (3) is stamped on the upper side of the rear crankcase.

The color label (4) is attached to the frame below the seat (page 140).

KEY NO. _____

FRAME NO. _____

ENGINE NO. _____

COLOR _____

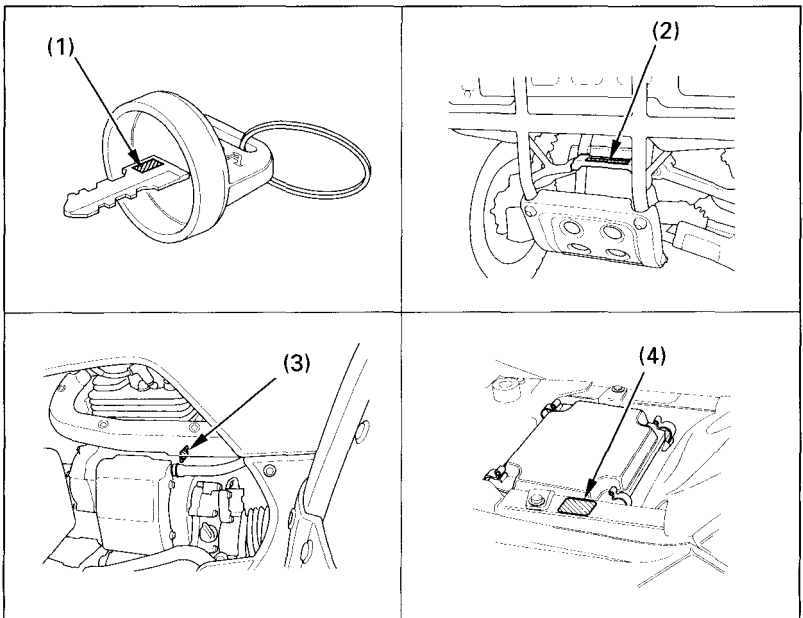

Fig. 5-1 (1) Key number
(2) Frame number

(3) Engine number
(4) Color label