

CARBURETOR

Choke Cable and Lever

Check the condition of the choke cable (Fig. 4-8) and the operation of the choke lever (2). If the cable is damaged or kinked, have it replaced by your Honda dealer.

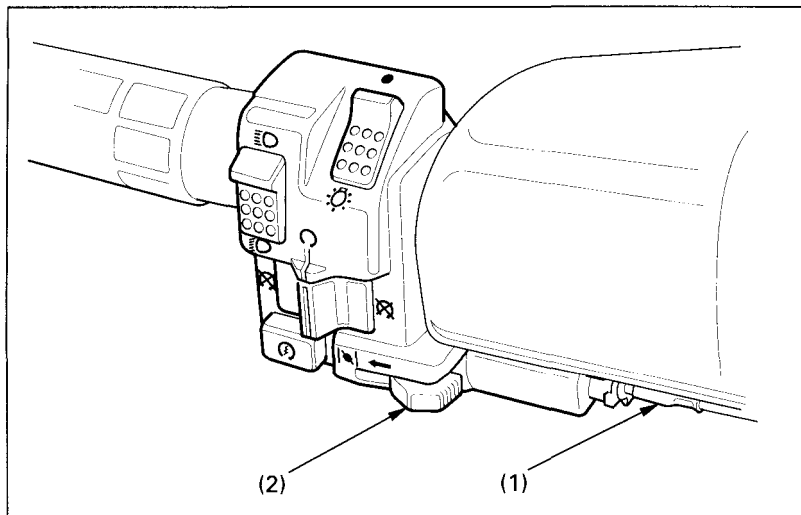

Fig. 4-8 (1) Choke cable

(2) Choke lever