

## ENGINE GUARD AND SKID PLATES

The engine guard (Fig. 4-33) protects the engine crankcase. The skid plates (2) protect the frame/lower arm, the drive components and the rear brake. Check the guard and plates for cracks, damage or looseness at intervals shown in the Maintenance Schedule (page 78–79).

Replace the guard and plates with new ones if they are cracked or damaged. If the guard and plate bolts are loose, tighten them securely.

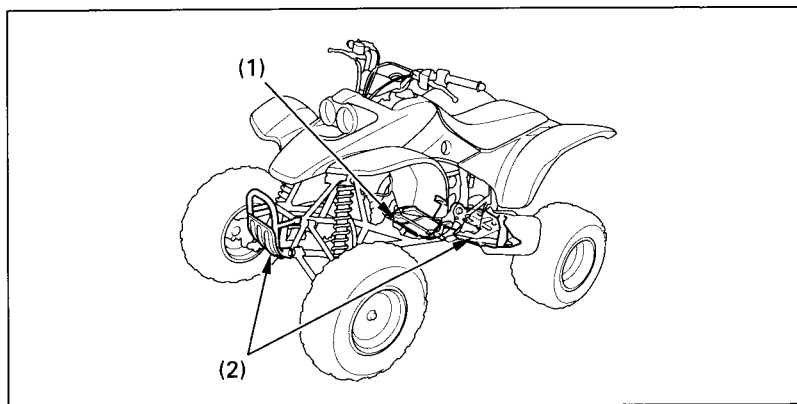

Fig. 4-33 (1) Engine guard

(2) Skid plates