

5. Push down the parking brake pin (6) and then squeeze the clutch lever (7) until firm resistance is felt. Measure the distance the clutch lever has moved; the distance should be:
1 – 1 3/16 in (25 – 30 mm)
If necessary, turn the adjuster (2) and tighten the lock nut (1).
6. Adjust the clutch lever free play (page 107) is:
3/8 – 13/16 in (10 – 20 mm)

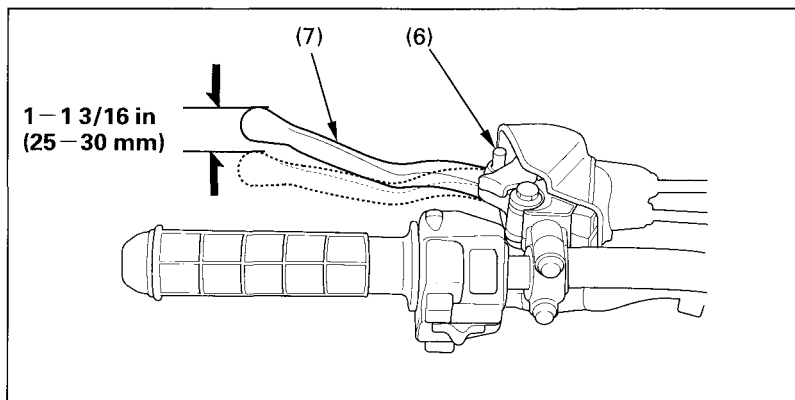

Fig. 4-28 (6) Parking brake pin

(7) Clutch/Parking
brake lever

While reading this manual, remember:

▲WARNING Indicates a strong possibility that serious injury or death may result if instructions are not followed.