

## SEAT REMOVAL

To remove the seat (Fig. 4-33), pull up the seat lock lever ( 1 ) behind the seat and lift it up.

If the muffler is hot, take care to lift the seat so that the rear fender does not touch the silencer.

### CAUTION:

**Allowing the rear fender to touch a hot muffler while removing the seat may damage the plastic.**

To install the seat, align the tabs on the seat with the grommets on the frame and press the seat down until it locks.

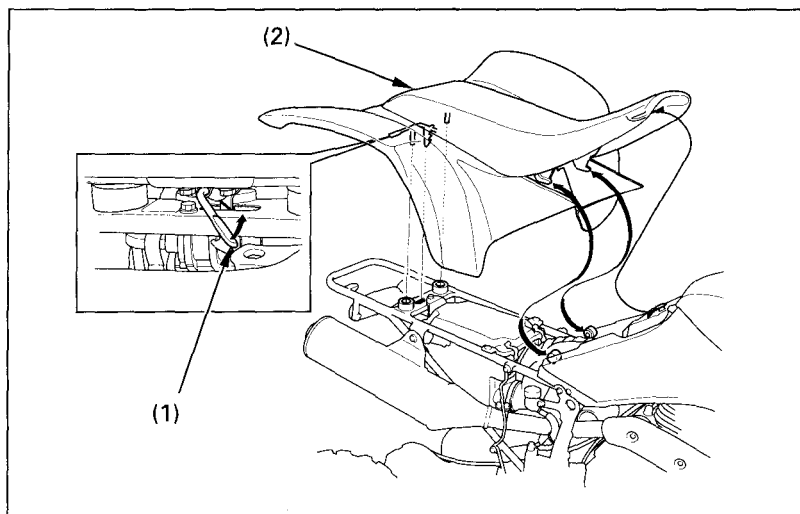

Fig. 4-33

(1) Seat lock lever

(2) Seat