

Seat Removal

Refer to *Safety Precautions* on page 91 .

The seat must be removed for air cleaner, battery and fuse maintenance.

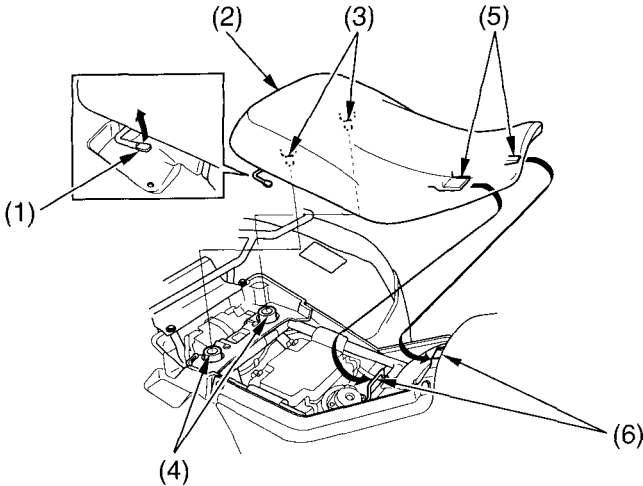

- (1) seat lock lever
- (2) seat
- (3) studs

- (4) grommets
- (5) front prongs
- (6) hooks

Removal

1. Pull the seat lock lever (1) at the right side of the seat.
2. Pull the seat (2) up from the rear to remove the studs (3) from the grommets (4).
3. Slide the seat back and up.

Installation

1. Insert the front prongs (5) into the hooks (6) on the frame and press the studs into the grommets.
2. Press down on the seat until locks.