

To check and adjust brake lever free play:

Measure the distance the rear brake lever moves before the brake starts to take hold. Free play, measured at the tip of the brake lever (Fig. 4-31 ), should be:

9/16 – 13/16 in (15 – 20 mm)

To adjust the free play, turn the brake lever adjusting nut (2), (Fig. 4-30 ), located on the brake operating rod at the rear of the frame. Make sure the cut-out on the adjusting nut is properly seated on the brake arm pin (3).

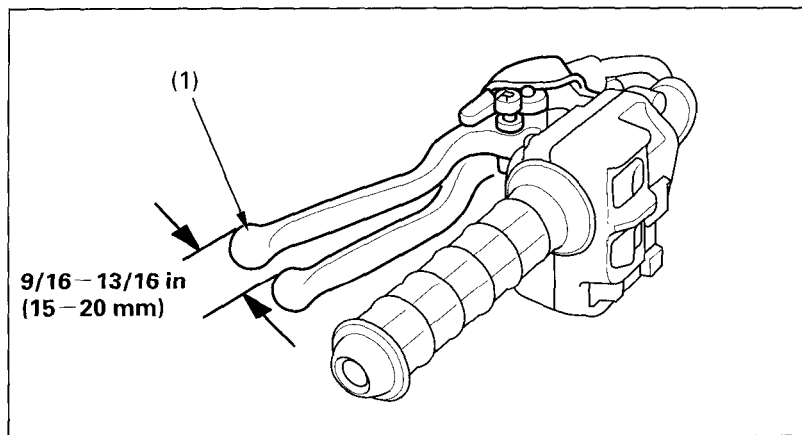

Fig. 4-31

(1) Brake lever