

To adjust the brake lining clearance:

1. Squeeze the brake lever firmly two or three times then release it.
2. Raise the front and rear wheels off the ground by placing a support block under the vehicle.
3. Beginning with either the left or right front wheel, remove the inspection hole plug (Fig. 4-26) and line up the hole with one of the brake adjusters (Fig. 4-27).
4. Using a screwdriver, turn the brake shoe adjuster (1) in the direction of the arrow until the front brake locks.

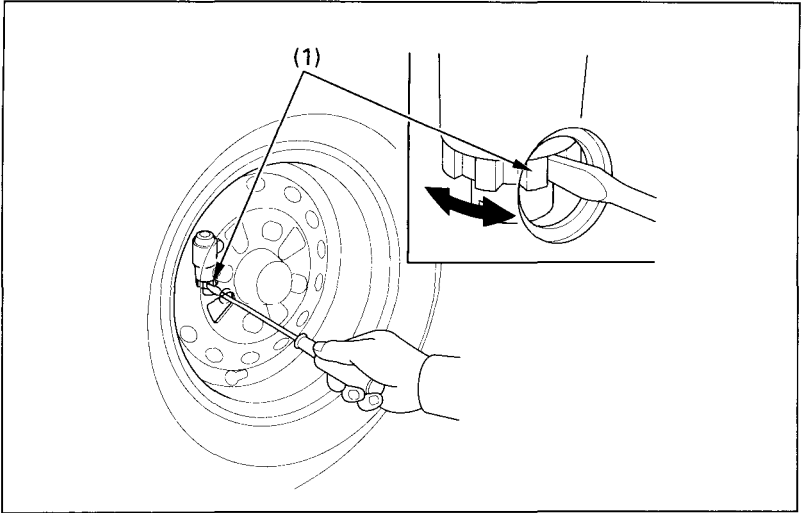

Fig. 4-27

(1) Brake adjusters

5. Back the adjuster off three clicks, then squeeze the brake lever several times. Spin the wheel manually to make sure the brake does not drag.
6. Line up the inspection hole with the second adjuster and repeat steps 3 through 5.
7. Reinstall the inspection hole plug, seating it into the inspection hole as shown in Fig. 4-26.
8. Follow steps 3 through 7 to adjust the other front brake.
9. Recheck the brake lever free play. If free play is still excessive after adjusting the brake lining clearance, there is probably air in the brake system and it must be bled out. See your authorized Honda dealer for this service.