

## Flag Pole Bracket

The flag pole bracket (Fig. 2-26) is on the rear cargo rack. Flag poles are optional equipment available from your Honda dealer. To mount a pole in the bracket, follow the instructions that come with the flag pole kit.

### NOTE:

Flag poles are required in some riding areas. Check local regulations before riding.

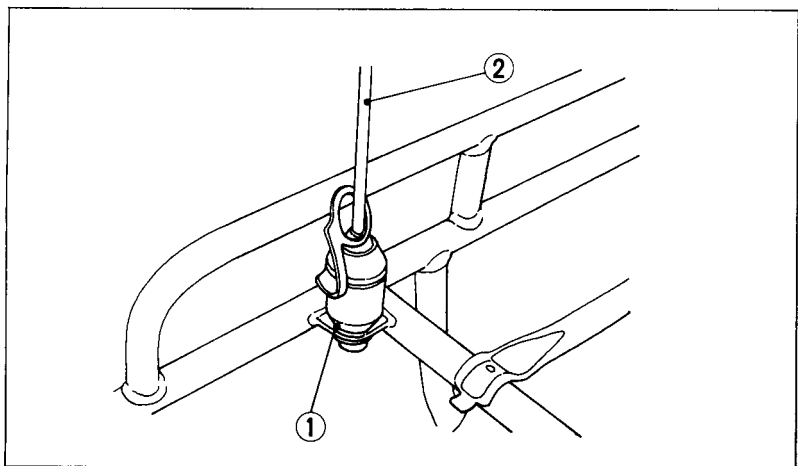

Fig. 2-26 (1) Flag pole bracket (2) An example flag pole

## Trailer Hitch

The trailer hitch is located on the rear axle housing. As illustrated in Fig. 2-27, to use the hitch, you'll need a proper size ball as specified by the trailer manufacturer.

To attach the ball and properly hook up a trailer, follow the trailer manufacturer's instructions. For load limits and operational guidelines, see pages 43–45.