

FUSE

As illustrated in Fig. 4-18, the fuse (2) is located in the battery compartment.

A spare fuse is located in the owner's manual storage area under the seat (page 35).

The specified fuse is:

15 A

If a fuse fails frequently, it usually indicates a short circuit or an overload in the electrical system. See your authorized Honda dealer for repair.

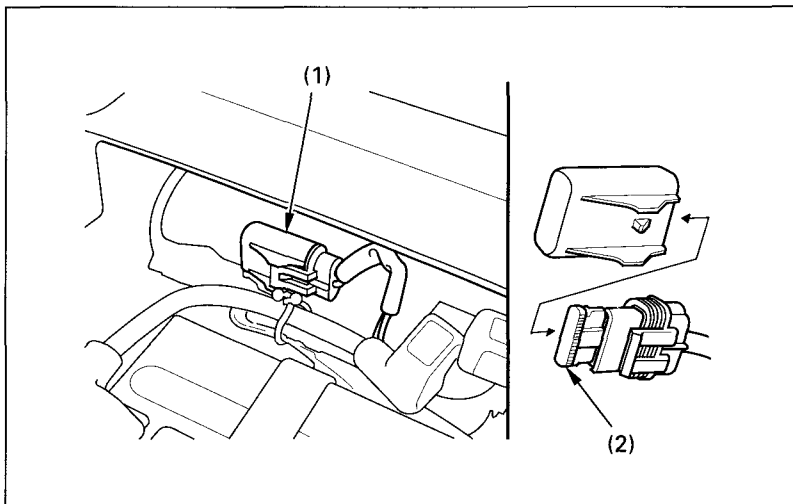

Fig. 4-18

(1) Fuse holder assembly
(2) Fuse