

Battery Removal

1. Make sure the ignition switch is ○ (OFF).
2. Remove the seat (page 128).
3. Release the rings and remove the rubber band (2).
4. Disconnect the negative (−) terminal lead (3) from the battery (1) first, then disconnect the positive (+) terminal lead (4).
5. Remove the battery.
 - * Install in the reverse order of removal.
 - * Check all bolts and other fasteners are secure.
 - * After installing the battery, check to see if the battery cables are routed correctly.

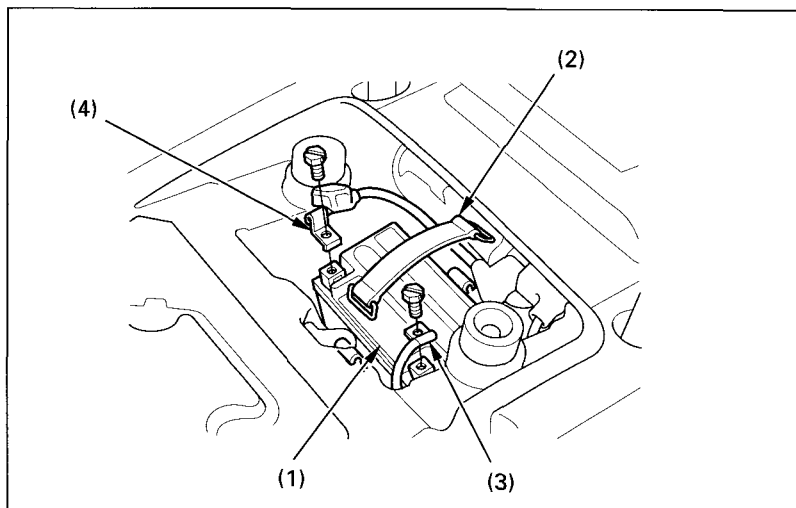

Fig. 4-17

(1) Battery
(2) Rubber band

(3) Negative (−) terminal lead
(4) Positive (+) terminal lead