

- (14) Flag pole bracket
- (15) Seat lock lever
- (16) Fuel valve
- (17) Oil filler cap/dipstick
- (18) Gearshift pedal
- (19) Operator footpeg

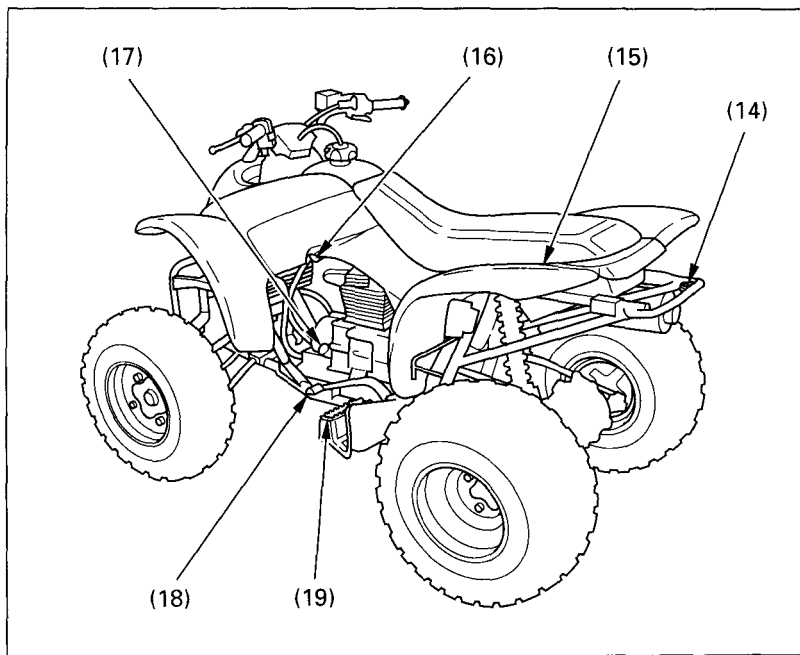

Fig. 2-3

Left side of Sportrax