

## REAR COWL

### Removal:

1. Remove the seat (page 38).
2. Remove the cap (1), bolts (2) and washers (3).
3. Remove the rear grab rail (4).
4. Remove the bolts (5) and washers (6).
5. Carefully pry up on the front prongs (7) of the rear cowl (8) and remove the rear cowl (8) by sliding it toward the rear.

### Installation:

- Installation can be done in the reverse order of removal.

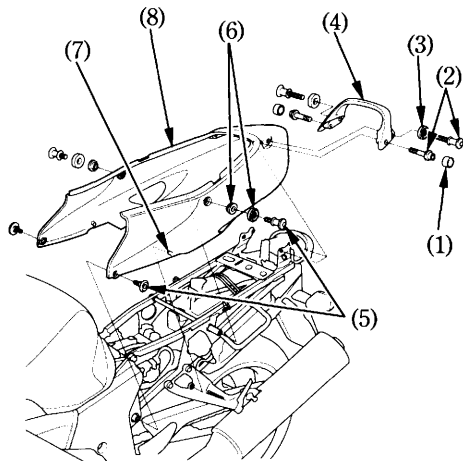

- |                    |               |
|--------------------|---------------|
| (1) Cap            | (5) Bolts     |
| (2) Bolts          | (6) Washers   |
| (3) Washer         | (7) Prong     |
| (4) Rear grab rail | (8) Rear cowl |