

INNER PANEL

The right and left inner panels can be removed in the same manner.

Removal:

1. Remove the lower cowl (page 58) and upper cowl cover (page 60).
2. Remove the clip A (1).
3. Remove the clip B (2).
4. Remove the inner panel (3) by releasing it from the frame boss (4).
5. Remove the inner panel (3) by releasing it from the grommets (5) on the fuel tank.

Installation:

- Installation can be done in the reverse order of removal.

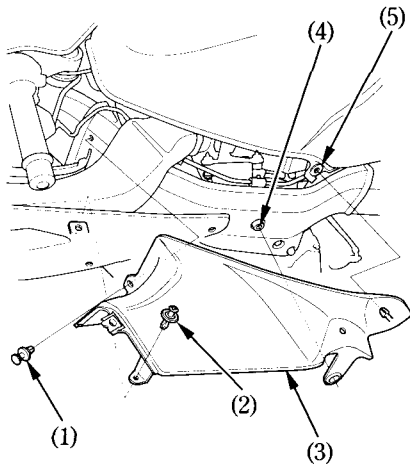

- (1) Clip A
(2) Clip B
(3) Inner panel

- (4) Frame boss
(5) Grommet