

## Battery Removal

The battery (1) is in the battery box behind the right side cover.

1. Remove the right side cover (page 50).
2. Unhook the strap (2).
3. Disconnect the negative (-) terminal lead (3) from the battery first, then disconnect the positive (+) terminal lead (4).
4. Pull out the battery (1) from the battery box.

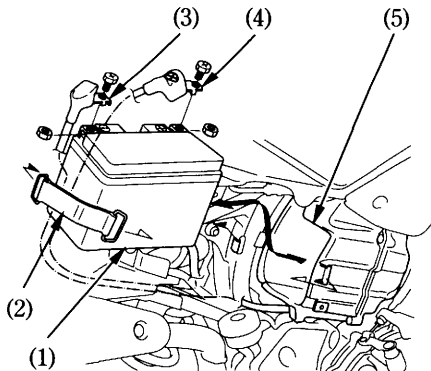

- (1) Battery
- (2) Strap
- (3) Negative (-) terminal lead
- (4) Positive (+) terminal lead
- (5) Battery box