

DOCUMENT COMPARTMENT

The document compartment (1) is under the seat.

This owner's manual and other documents should be stored in the compartment.

When washing your motorcycle, be careful not to flood this area with water.

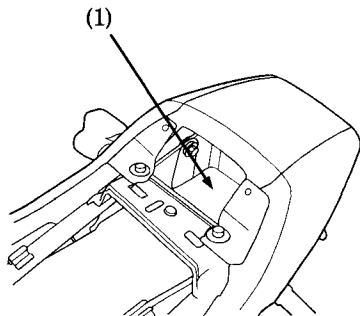

(1) Document compartment

SIDE COVER

To remove the side cover (1), remove the seat (see page 29), bolts (2) and pull out the studs (3).

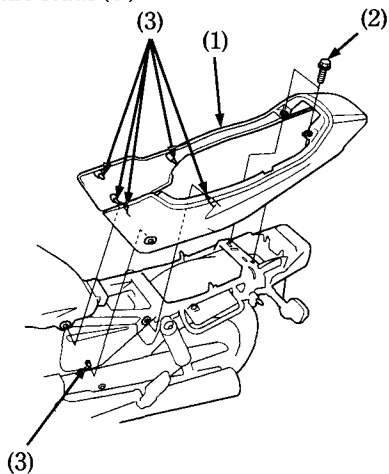

(1) Side cover
(2) Bolts

(3) Studs